

Article number: 0101074  
 Description: Retaining ring A 57 DIN 471  
 Spring steel  
 Note: Fitted with ZGA pilers

## Measures

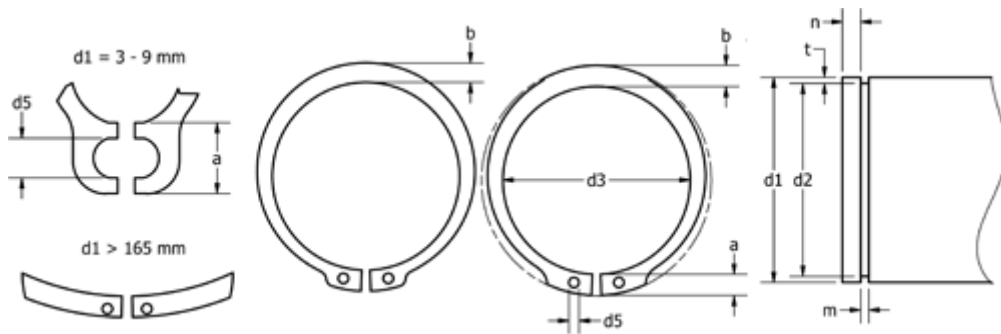

a max	= 7.3	FN kN	= 43.7	s	= 2.00
AN mm <sup>2</sup>	= 262.0	FRg kN	= 11.40	t	= 1.50
b	= 5.5	FR kN	= 70.90	tol	= -0.30
d1	= 57	g	= 2.5	tol	= -0.07
d2	= 54.0	K kN-mm	= 128.00	tol	= +0,46-1,10
d3	= 52.8	m min	= 2.15	Tong	= ZGA-3
d5 min	= 2.5	n abl x 1000	= 8.0	Weight kg/1000	= 12.200
Description	= A57	Nominal drive	= 4.5		